



---

# VIP5662 IPTV Receiver Installation Guide

---





TO REDUCE RISK OF ELECTRIC SHOCK, DO NOT REMOVE COVER (OR BACK). NO USER-SERVICEABLE PARTS INSIDE. REFER SERVICING TO QUALIFIED SERVICE PERSONNEL.

Graphical symbols and supplemental warning markings are located on the back and bottom of the terminal.

### **WARNING**

TO REDUCE THE RISK OF FIRE OR SHOCK, DO NOT EXPOSE THIS APPLIANCE TO RAIN OR MOISTURE.



The lightning flash with arrowhead symbol within an equilateral triangle is intended to alert the user to the presence of uninsulated dangerous voltage within the product's enclosure that may be of sufficient magnitude to constitute a risk of electric shock to persons.



The exclamation point within an equilateral triangle is intended to alert the user to the presence of important operating and maintenance (servicing) instructions in the literature accompanying the appliance.

Product identification and supply rating are provided on the label found on the bottom of the unit.

### **IMPORTANT SAFETY INSTRUCTIONS**

- Read these instructions.
- Keep these instructions.
- Heed all warnings.
- Follow all instructions.
- Do not use this apparatus near water.
- Clean only with a dry cloth.
- Do not block any ventilation openings. Install according to the manufacturer's instructions.
- Do not install near any heat sources, such as radiators, heat registers, stoves, or other apparatus (including amplifiers) that produce heat.
- Protect the power cord from being walked on or pinched, particularly at plugs, convenience receptacles, and the point where they exit from the apparatus.
- Only use attachments/accessories specified by the manufacturer.
- Unplug this apparatus during lightning storms or when unused for long periods of time.
- Refer all servicing to qualified service personnel. Servicing is required when the apparatus has been damaged in any way, such as the power supply cord or plug is damaged, liquid has been spilled or objects have fallen into the apparatus, the apparatus has been exposed to rain or moisture, does not operate normally, or has been dropped.

This manual includes the manufacturer's recommended safeguards and all the information needed to connect your receiver to both your in-home IP network and your entertainment system. The safety and installation information was developed and provided primarily by the receiver manufacturer, ARRIS Enterprises, Inc.



Follow these important safety guidelines when positioning and connecting your receiver:

- Do not block the slots and openings.
- Do not place anything on top of the receiver.
- Do not position the receiver in a confined space, such as an enclosed cabinet, that does not provide adequate ventilation.
- Do not position the receiver near any external heat source that could raise the temperature around the unit. Do not place the receiver on top of another heat producing electronic device.
- Allow for adequate ventilation around the receiver to maintain normal operating temperature. Do not place it in a sealed enclosure without providing for adequate airflow.
- Use only the power adapter and cord supplied to connect the VIP5662 to your home AC power outlet.
- Do not plug the AC power adapter into a switched power outlet.
- Always transport the receiver in its original factory carton, or in an equally well-padded container.
- Whether installed or being transported, do not expose the receiver to temperature extremes. The temperature range for operation is from 0° to +40°C. The non-operating (transport or storage) temperature range is from -40° to +60°C.

**WARNING:** TO PREVENT FIRE OR SHOCK HAZARD, DO NOT EXPOSE THIS PRODUCT TO RAIN OR MOISTURE. THE UNIT MUST NOT BE EXPOSED TO DRIPPING OR SPLASHING. DO NOT PLACE OBJECTS FILLED WITH LIQUIDS, SUCH AS VASES, ON THE UNIT.

**CAUTION:** THIS PRODUCT WAS QUALIFIED UNDER TEST CONDITIONS THAT INCLUDED THE USE OF THE SUPPLIED CABLES BETWEEN SYSTEMS COMPONENTS. TO ENSURE REGULATORY AND SAFETY COMPLIANCE, USE ONLY THE PROVIDED POWER AND INTERFACE CABLES AND INSTALL THEM PROPERLY.

**CAUTION:** DIFFERENT TYPES OF CORD SETS MAY BE USED FOR CONNECTIONS TO THE MAIN SUPPLY CIRCUIT. USE ONLY A MAIN LINE CORD THAT COMPLIES WITH ALL APPLICABLE PRODUCT SAFETY REQUIREMENTS OF THE COUNTRY OF USE.

**CAUTION:** INSTALLATION OF THIS PRODUCT MUST BE IN ACCORDANCE WITH NATIONAL WIRING CODES AND CONFORM TO LOCAL REGULATIONS.

**CAUTION:** DO NOT OPEN THE UNIT. DO NOT PERFORM ANY SERVICING OTHER THAN THAT CONTAINED IN THE INSTALLATION AND TROUBLESHOOTING INSTRUCTIONS. REFER ALL SERVICING TO QUALIFIED SERVICE PERSONNEL.

**CAUTION:** CHANGES AND MODIFICATIONS NOT EXPRESSLY APPROVED BY ARRIS FOR COMPLIANCE COULD VOID USER'S AUTHORITY TO OPERATE THE EQUIPMENT

# Contents

Introduction .....	1
Overview .....	2
Top View and Front Panel .....	2
Rear Panel .....	3
Remove Hard Drive Procedure .....	4
Insert Hard Drive Procedure .....	5
Connecting Your TV Receiver .....	6
Digital Audio/Video Connections .....	8
Component Video and Digital Audio Connections .....	9
Composite Video and Stereo Audio Connections .....	10
Troubleshooting .....	11

# Introduction

Congratulations on receiving your ARRIS VIP5662 IPTV Receiver.

The VIP5662 provides these extraordinary home entertainment features:

- Ultra High Definition TV (UHDTV), with up to twice the color resolution and up to six times the sharpness of standard TV when connected to a UHD-capable TV
- A direct digital connection to consumer audio and video devices through multiple interfaces
- Bluetooth connectivity via remote control unit. Refer to your service provider for more information

This installation manual introduces the basic features, outlines important safeguards, and provides options for integrating your receiver into your entertainment system. Please take a few moments to read through this manual. Its configuration diagrams and troubleshooting section will help you make the most of your home entertainment experience.

## Included in the carton:

- VIP5662 Ultra High-Definition (UHD)
- Power adapter
- Other accessories may be included

For more information about your TV service, refer to the other documentation from your service provider.

## Wired Connection

Plug the power adapter into a wall socket and into the rear panel of the receiver. Plug an Ethernet cable into the network port of the receiver. Verify the following:

- The Ethernet LEDs located on the rear panel light and behave as indicated on page 3 of this manual
- The link LED located on the front panel lights and behaves as indicated on page 2 of this manual.

## Overview

### Top and Front Panel

The illustrations below (Top view and Front Panel view, respectively) and the table following describe the top/front-panel features, controls, and indicator lights.

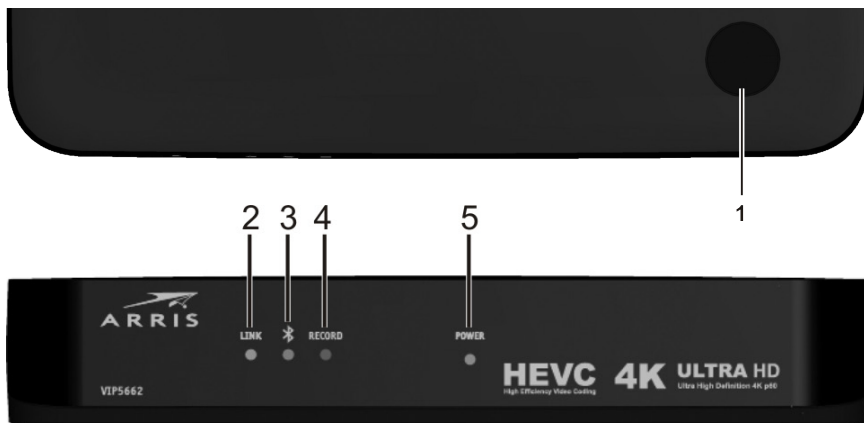

Key	Item	Function
1	POWER BUTTON	Press to turn the receiver on or place the unit in standby mode. If held for five (5) seconds or longer, restarts the receiver.
2	LINK	<ul style="list-style-type: none"><li>No light: No Ethernet connection (Off)</li><li>Blinking green: Receiver connecting to network</li><li>Solid green: Network connection enabled (On)</li></ul>
3	BLUETOOTH	No light: No bluetooth Blinking blue: Receiver is pairing with the RCU Solid blue: Receiver is paired with the RCU
4	RECORD	No light: Not recording Solid red: Recording is in progress
5	POWER	No light: Receiver is off Solid green: Receiver is on

## Overview

### Rear Panel

The illustration below and the table following list the rear-panel features, controls, and connectors of the VIP5662.

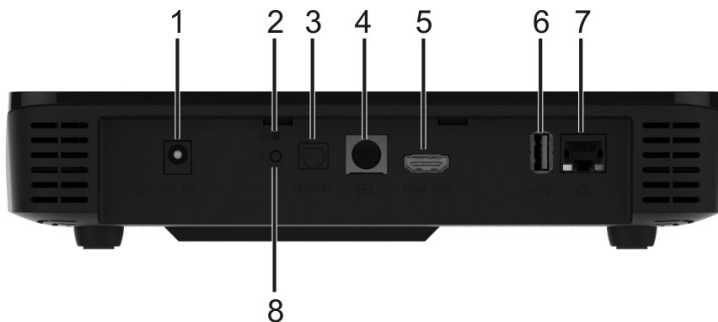

Key	Item	Function
1	POWER +12 VDC	Connector for the DC power adapter. Use only the adapter specified for this VIP5662.
2	RESET BUTTON	Press and release to trigger the System Recovery Process.
3	OPTICAL	TOSLink (S/PDIF) digital audio output.
4	BREAKOUT CABLE CONNECTION	Alternative method for video/audio connections. Offers analog component, composite, and stereo audio outputs.
5	HDMI™ OUT	Connects to a High Definition TV or home theater receiver with an HDMI input (for a DVI input, use an HDMI-to-DVI adapter).
6	USB 3.0	Allows connectivity with USB 3.0 devices.
7	NETWORK	Ethernet 10/100/1000Base-T RJ-45 port. Link LED: Lights green when Ethernet connection detected. Activity LED: Flashes amber with data traffic.
8	BLUETOOTH PAIRING	Press and release to initiate Bluetooth remote control unit pairing with receiver. Hold the button for 10 seconds to unpair the Bluetooth remote control unit and the receiver.

## Remove Hard Drive Procedures

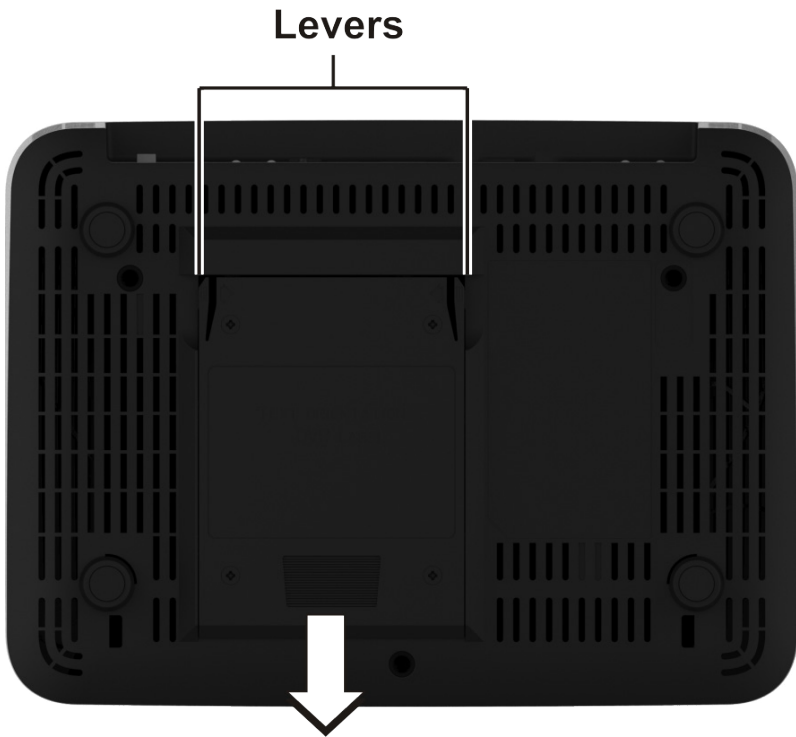

**To remove the Hard Drive from the VIP5662, perform the following procedure:**

1. Turn unit off.
2. Flip unit upside down.
3. Grip levers on either side of hard drive compartment and squeeze to release.
4. Slide hard drive out of compartment then lift up to remove.



## Insert Hard Drive Procedures

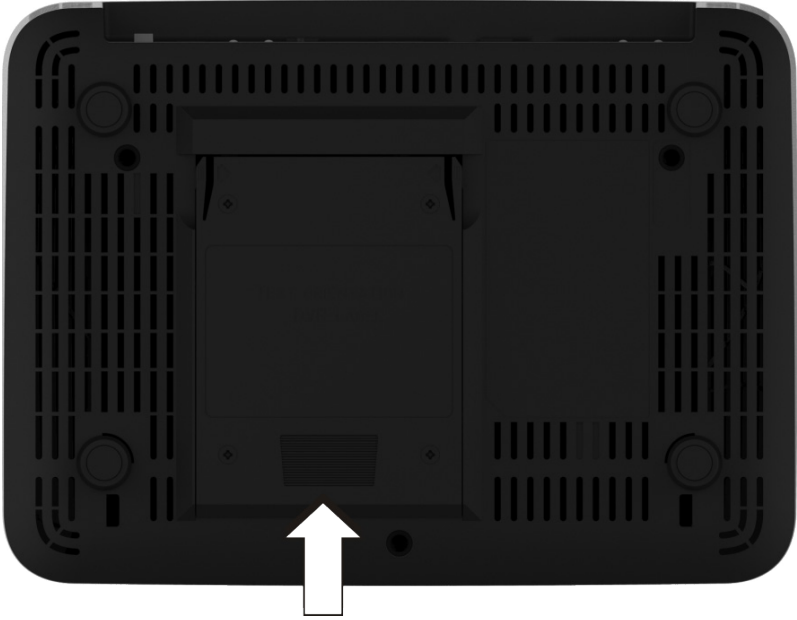

**To insert the Hard Drive into the VIP5662, perform the following procedure:**

1. Turn unit off.
2. Flip unit upside down.
3. Slide hard drive cover-side up into compartment until you hear it click.

## Connecting Your TV Receiver

This section describes alternative methods for connecting the VIP5662 to your home entertainment system.

Instructions and diagrams are included for the following connections:

- Digital Audio/Video
- Component Video and Digital Audio
- Composite Video and Stereo Audio

Before you move or change components on your entertainment system, always disconnect power from the receiver.

### Connection Options

The VIP5662 offers the following video outputs:







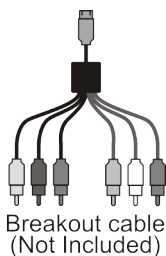

<b>Ultra HDTV</b>	HDMI
<b>HDTV</b>	HDMI, Component (cable not included)
<b>Standard</b>	HDMI, Composite or Component (cables not included)

To determine the available inputs on your TV, check the manual supplied with the TV or on the TV itself. Use the following guidelines to determine the best connections for your system. Use one of the following.

<b>Connector</b>		<b>Description</b>
<b>High-Definition</b>	<b>HDMI</b> 	HDMI offers higher video quality than component video. If your HDTV has an HDMI input, use the HDMI connector.  HDMI provides both digital video and digital audio (including Dolby® Digital 5.1 Surround Sound). No other connections are necessary.  If your HDTV has a DVI input, you can use an HDMI-to-DVI converter cable to connect to the VIP5662W HDMI connector. Use a cable with an HDMI connector on one end and a DVI connector on the other end. We do not recommend using an HDMI-to-DVI or DVI-to-HDMI adapter. Because DVI does not carry audio, a separate audio connection is required for a DVI TV. If your TV has an optical S/PDIF audio connection, use the OPTICAL connection. Otherwise, use the baseband AUDIO L and R connections.

## Connecting Your TV Receiver



Connector	Description
<b>Component</b>  Y  Pb  Pr	The component outputs provide component video outputs using the three standard video connections: Y, Pb, Pr (green, blue, red).
<b>Audio +Composite</b>   Video  Audio L  Audio R	The Audio +Composite output provides both composite video and baseband stereo audio using RCA connectors.  Composite video provides a Standard-Definition analog video signal using the video RCA connector (yellow) and the stereo audio RCA connectors (white/left, red/right).
<b>Optical Audio</b> 	If your equipment supports an optical S/PDIF audio connection, use the OPTICAL connection for the audio.

### Common Cabling Examples

The following cabling diagrams illustrate common sample audio/video (A/V) connections. When connecting other components to your receiver, refer to the other component installation manuals for additional connection information.

## Digital Audio/Video Connections

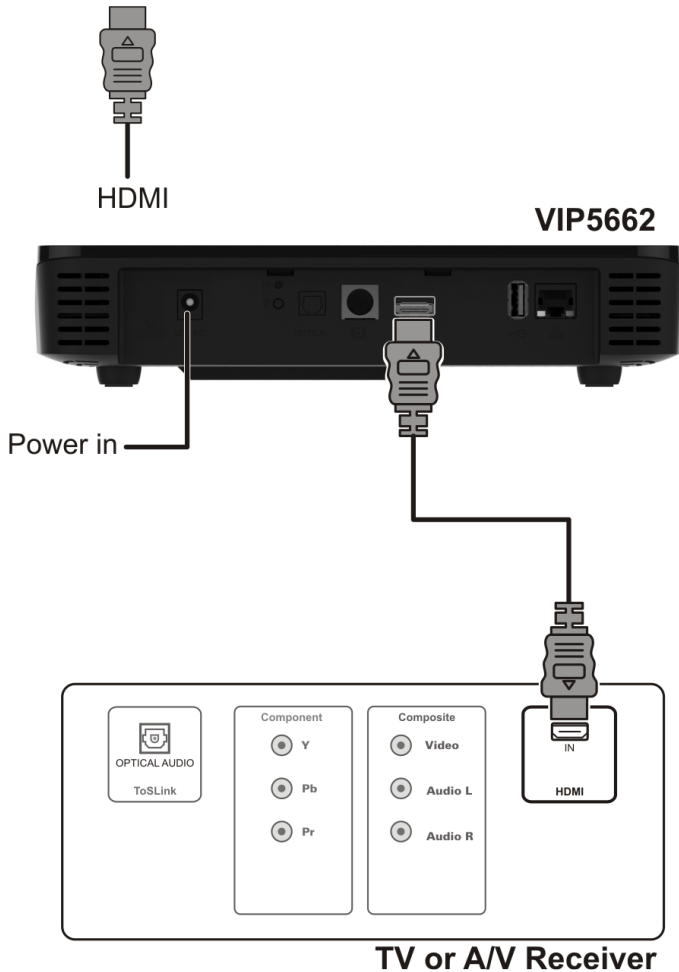

- If your HDTV has an HDMI input, connect an HDMI cable to the HDMI connector as shown. The HDMI connection carries both digital video and digital audio signals.
- If your HDTV has a DVI input, you can use an HDMI-to-DVI converter to connect to the VIP5662 HDMI connector. DVI video carries video signals only. Use the optical audio or stereo audio connectors to provide audio output.

## Component Video and Digital Audio Connections

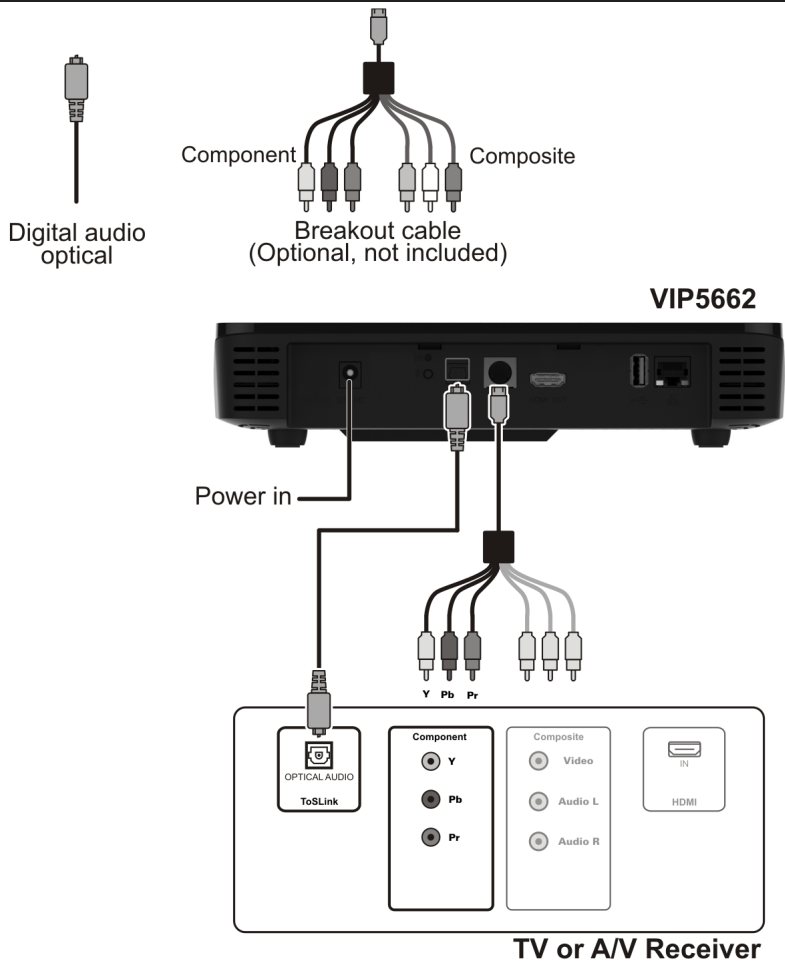

If you use a DVI video input to connect to your TV, you will need to provide a separate connection for the audio. Use the OPTICAL S/PDIF output, which offers digital audio quality, including support for Dolby Digital 5.1 Surround Sound.

If your HDTV has component inputs available, connect the component outputs from a Breakout cable to the correct inputs on your HDTV (as shown).

If your HDTV or A/V receiver has an optical audio input available, use a Digital Optical Audio cable to connect from the VIP5662 to the correct input on your HDTV or receiver (as shown).

NOTE: If you choose to configure stereo audio instead of digital audio, connect the composite outputs for Audio Left and Audio Right rather than the Optical Audio, as shown.

## Composite Video and Stereo Audio Connections

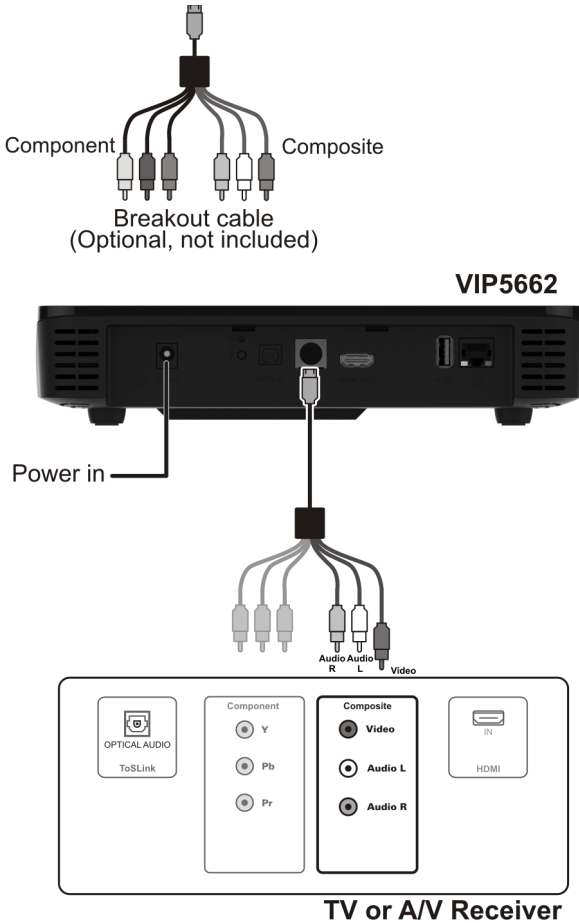

If your HDTV has composite video and analog stereo inputs, connect the composite outputs using a Breakout cable to the correct inputs on your HDTV (as shown).

Do not connect the unit through a VCR. Video signals fed through VCRs may be affected by copyright protection systems and the picture will be distorted on the television.

## Troubleshooting

Before calling your service provider, review this troubleshooting guide and your RCU users guide. If the suggestions do not help you quickly solve a problem, contact your service provider.

<b>Problem</b>	<b>Possible Solution</b>
<b>The receiver will not power on.</b>	<p>Verify that the power adapter is connected to the receiver and an AC outlet.</p> <p>Unplug the wireless receiver from the AC outlet, plug it back in, and press the POWER button.</p> <p>If the receiver is connected to a switched outlet on a wall or another unit, verify the switch or unit is powered on.</p> <p>Press the POWER button on the receiver front panel instead of the remote control. The batteries in the remote control may be depleted.</p>
<b>The remote control does not work.</b>	<p>Verify that the TV is on.</p> <p>Verify that the STB mode LED on the remote control is lit.</p> <p>Verify that there are no obstructions between the remote control and the receiver. Aim the remote control directly at the receiver front panel, not the TV or VCR.</p> <p>The angle between the remote control and the receiver may be too large. Stand in front of the receiver and not too far to either side.</p> <p>Press and release operation keys one at a time, firmly and deliberately.</p> <p>Check the batteries in the remote control. Install new batteries if needed.</p>
<b>Video or audio quality is poor or missing.</b>	<p>To improve video quality, upgrade your connection (from composite analog to component+digital audio to HDMI).</p>

## Troubleshooting

Problem	Possible Solution
<b>There is no audio when viewing TV channels.</b>	<p>Verify that the Mute button on the remote control has not been pressed. Press Mute on the remote control to restore sound.</p> <p>If the receiver audio output is connected to the TV, verify that the Mute button on the TV has not been pressed.</p> <p>If the receiver audio output is connected to a home theater receiver, verify that the home theater receiver is set to the appropriate input source and its Mute button has not been pressed.</p> <p>Verify that you have the correct cables for the audio ports.</p> <p>Verify that the audio cables are firmly connected between the receiver and the audio playback device (TV, home theater receiver, etc.).</p>
<b>There is no audio from the center and/or surround speakers of a home theater receiver connected to the receiver.</b>	<p>Not all Dolby Digital programs feature full 5.1 surround sound. In some cases, the programs may only contain left and right stereo audio.</p> <p>Verify that the Optical S/PDIF cable is firmly connected to the wireless receiver and the home theater receiver.</p> <p>Verify that the home theater receiver is set to a surround sound audio mode (Dolby Digital, Dolby Pro Logic® II, Dolby Pro Logic).</p> <p>Verify that the home theater receiver is properly configured to work with all connected speakers.</p>



## Regulatory Information

### Federal Communications Commission Radio and Television Interference Statement for a Class 'B' Device

This equipment has been tested and found to comply with the limits for a Class B digital device, pursuant to part 15 of the FCC Rules. These limits are designed to provide reasonable protection against harmful interference in a residential installation. This equipment generates, uses, and can radiate radio frequency energy and, if not installed and used in accordance with the instructions, may cause harmful interference to radio communications. However, there is no guarantee that interference will not occur in a particular installation.

If the equipment does cause harmful interference to radio or television reception, which can be determined by turning the equipment off and on, the user is encouraged to try to correct the interference by one of the following measures:

- Reorient or relocate the receiving antenna.
- Increase the separation between the equipment and the receiver.
- Connect the equipment into an outlet on a circuit different from the one the receiver is connected.
- Consult the dealer or an experienced radio/TV technician for help.

FCC Caution: Any changes or modification not expressly approved by the party responsible for compliance could void the user's authority to operate this equipment.

This device complies with Part 15 of the FCC Rules. Operation is subject to the following two conditions: (1) This device may not cause harmful interference, and (2) this device must accept any interference received, including interference that may cause undesired operation

#### **IMPORTANT NOTE: Radiation Exposure Statement.**

The equipment complies with FCC radiation exposure limits set forth for an uncontrolled environment. This equipment should be installed and operated with minimum distance of 20cm between the radiator and your body.

This transmitter must not be co-located or operating in conjunction with any other antenna or transmitter.

Country Code selection feature to be disabled for products marketed to the US/CANADA. Operation of this device is restricted to indoor use only.

#### **FCC Declaration of Conformity**

According to 47 CFR, Parts 2 and 15 for Class B Personal Computers and Peripherals; and/or CPU Boards and Power Supplies used with Class B Personal Computers, ARRIS Enterprises, Inc, 3871 Lakefield Drive, Suwanee, Georgia 30024, declares under sole responsibility that the product identifies with 47 CFR Part 2 and 15 of the FCC Rules as a Class B digital device. Each product marketed is identical to the representative unit tested and found to be compliant with the standards. Records maintained continue to reflect the equipment being produced can be expected to be within the variation accepted, due to quantity production and testing on a statistical basis as required by 47 CFR 2.909. Operation is subject to the following condition: This device must accept any interference received, including interference that may cause undesired operation. The above named party is responsible for ensuring that the equipment complies with the standards of 47 CFR, Paragraphs 15.101 to 15.109.

#### **Innovation, Science and Economic Development Canada statement;**

This device complies with Innovation, Science and Economic Development Canada's licence-exempt RSS standard(s). Operation is subject to the following two conditions: (1) this device may not cause interference, and (2) this device must accept any interference, including interference that may cause undesired operation of the device. Le présent appareil est conforme aux CNR d'Industrie Canada applicables aux appareils radio exempts de licence. L'exploitation est autorisée aux deux conditions suivantes:

- 1) l'appareil ne doit pas produire de brouillage;
- 2) l'utilisateur de l'appareil doit accepter tout brouillage radioélectrique subi, même si le brouillage est susceptible d'en compromettre le fonctionnement.

#### **Canadian Compliance**

This Class B digital device complies with Canadian ICES 003. Cet appareil numérique de la classe B est conforme à la norme NMB 003 du Canada.

#### **IMPORTANT NOTE:**

##### **Canada Radiation Exposure Statement**

This equipment complies with Canada radiation exposure limits set forth for an uncontrolled environment. This equipment should be installed and operated with minimum distance 20cm between the radiator and your body.

Under Industry Canada regulations, this radio transmitter may only operate using an antenna of a type and maximum (or lesser) gain approved for the transmitter by Industry Canada. To reduce potential radio interference to other users, the antenna type and its gain should be so chosen that the equivalent isotropically radiated power (EIRP) is not more than that necessary for successful communication.

**NOTE IMPORTANTE: (Pour l'utilisation de dispositifs mobiles)  
Déclaration d'exposition aux radiations**

Cet équipement est conforme Canada limites d'exposition aux radiations dans un environnement non contrôlé. Cet équipement doit être installé et utilisé à distance minimum de 20cm entre le radiateur et votre corps.

## Software License

VIP5602/5662 IPTV Receiver  
ARRIS Enterprises, Inc. ("ARRIS")  
3871 Lakefield Drive  
Suwanee, Georgia 30024, USA

**IMPORTANT: PLEASE READ THIS SOFTWARE LICENSE ("LICENSE") CAREFULLY BEFORE YOU USE ANY SOFTWARE, FIRMWARE, AND RELATED DOCUMENTATION ("SOFTWARE") PROVIDED WITH ARRIS' IP VIDEO RECEIVER OR HOME THEATER SYSTEM (EACH SHALL BE REFERRED TO IN THIS LICENSE AS A "RECEIVER"). BY USING THE RECEIVER AND/OR USING ANY OF THE SOFTWARE, YOU INDICATE YOUR ACCEPTANCE OF EACH OF THE TERMS OF THIS LICENSE. UPON ACCEPTANCE, THIS LICENSE WILL BE A LEGALLY BINDING AGREEMENT BETWEEN YOU AND ARRIS. THE TERMS OF THIS LICENSE APPLY TO YOU AND TO ANY SUBSEQUENT USER OF THIS SOFTWARE.**

**IF YOU DO NOT AGREE TO ALL OF THE TERMS OF THIS LICENSE (I) DO NOT USE THE SOFTWARE AND (II) RETURN THE RECEIVER AND THE SOFTWARE (COLLECTIVELY, "PRODUCT"), INCLUDING ALL COMPONENTS, DOCUMENTATION, AND ANY OTHER MATERIALS PROVIDED WITH THE PRODUCT, TO YOUR POINT OF PURCHASE OR SERVICE PROVIDER, AS THE CASE MAY BE, FOR A FULL REFUND.**

The Software includes associated media, any printed materials, and any "on line" or electronic documentation. Software provided by third parties may be subject to separate end user license agreements from the manufacturers of such Software. The Software is never sold. ARRIS licenses the Software to the original customer and to any subsequent licensee for personal use only on the terms of this License. ARRIS and its third party licensors retain the ownership of the Software.

### You may:

USE the Software only in connection with the operation of the Product.

TRANSFER the Software (including all component parts and printed materials) permanently to another person, but only if the person agrees to accept all of the terms of this License. If you transfer the Software, you must at the same time transfer the Product and all copies of the Software (if applicable) to the same person or destroy any copies not transferred.

TERMINATE this License by destroying the original and all copies of the Software (if applicable) in whatever form.

### You may not:

(1) Loan, distribute, rent, lease, give, sublicense, or otherwise transfer the Software, in whole or in part, to any other person, except as permitted under the TRANSFER paragraph above. (2) Copy or translate the User Guide included with the Software, other than for personal use. (3) Copy, alter, translate, decompile, disassemble, or reverse engineer the Software, including but not limited to modifying the Software to make it operate on non compatible hardware. (4) Remove, alter, or cause not to be displayed any copyright notices or startup message contained in the Software programs or documentation. (5) Export the Software or the Product components in violation of any United States export laws.

The Product is not designed or intended for use in on line control of aircraft, air traffic, aircraft navigation, or aircraft communications; or in design, construction, operation, or maintenance of any nuclear facility. ARRIS AND ITS THIRD PARTY LICENSORS DISCLAIM ANY EXPRESS OR IMPLIED WARRANTY OF FITNESS FOR SUCH USES. YOU REPRESENT AND WARRANT THAT YOU SHALL NOT USE THE PRODUCT FOR SUCH PURPOSES.

Title to this Software, including the ownership of all copyrights, mask work rights, patents, trademarks, and all other intellectual property rights subsisting in the foregoing, and all adaptations to and modifications of the foregoing, shall at all times remain with ARRIS and its third party licensors. ARRIS retains all rights not expressly licensed under this License. The Software, including any images, graphics, photographs, animation, video, audio, music, and text incorporated therein is owned by ARRIS or its third party licensors and is protected by United States copyright laws and international treaty provisions. Except as otherwise expressly provided in this License, the copying, reproduction, distribution, or preparation of derivative works of the Software, any portion of the Product, or the documentation is strictly prohibited by such laws and treaty provisions. Nothing in this License constitutes a waiver of ARRIS' rights under United States copyright law.

This License and your rights regarding any matter it addresses are governed by the laws of the State of Georgia, without reference to conflict of laws principles. THIS LICENSE SHALL TERMINATE AUTOMATICALLY if you fail to comply with the terms of this License.

ARRIS is not responsible for any third party software that is provided as a bundled application, or otherwise, with the Software or that is downloaded to, or otherwise installed on, the Product. This product is protected by certain intellectual property rights of Ericsson Corporation. Use or distribution of such technology outside of this product is prohibited without a license from Ericsson Corporation or an authorized Ericsson Corporation subsidiary.

## **U.S. Government Restricted Rights**

The Product and documentation is provided with RESTRICTED RIGHTS. The use, duplication or disclosure by the Government is subject to restrictions as set forth in subdivision (c)(1)(ii) of The Rights in Technical Data and Computer Software clause at 52.227 7013. The contractor/manufacturer is ARRIS Enterprises, Inc., 3871 Lakefield Drive, Suwanee, Georgia 30024, USA.

## Open Source Attributions

**ARRIS IPTV Set-top Model VIP5602/5662** For instructions on how to obtain a copy of any source code being made publicly available by ARRIS related to software used in these ARRIS products you may send your request in writing to:

**ARRIS Software Pedigree Operations  
2450 Walsh Avenue, Santa Clara, CA 95051, USA**

The ARRIS website <http://opensource.arris.com> also contains information regarding ARRIS' use of open source. ARRIS has created this website to serve as a portal for interaction with the software community at large.

This document contains additional information regarding licenses, acknowledgments and required copyright notices for open source packages used in these ARRIS products.

### **Broadcom CFE**

Copyright © 2000, 2001 Broadcom Corporation. All rights reserved.

#### *License Text:*

This software is furnished under license and may be used and copied only in accordance with the following terms and conditions. Subject to these conditions, you may download, copy, install, use, modify and distribute modified or unmodified copies of this software in source and/or binary form. No title or ownership is transferred hereby.

- 1) Any source code used, modified or distributed must reproduce and retain this copyright notice and list of conditions as they appear in the source file.
- 2) No right is granted to use any trade name, trademark, or logo of Broadcom Corporation. Neither the "Broadcom Corporation" name nor any trademark or logo of Broadcom Corporation may be used to endorse or promote products derived from this software without the prior written permission of Broadcom Corporation.
- 3) THIS SOFTWARE IS PROVIDED "AS-IS" AND ANY EXPRESS OR IMPLIED WARRANTIES, INCLUDING BUT NOT LIMITED TO, ANY IMPLIED WARRANTIES OF MERCHANTABILITY, FITNESS FOR A PARTICULAR PURPOSE, OR NON-INFRINGEMENT ARE DISCLAIMED. IN NO EVENT SHALL BROADCOM BE LIABLE FOR ANY DAMAGES WHATSOEVER, AND IN PARTICULAR, BROADCOM SHALL NOT BE LIABLE FOR DIRECT, INDIRECT, INCIDENTAL, SPECIAL, EXEMPLARY, OR CONSEQUENTIAL DAMAGES (INCLUDING, BUT NOT LIMITED TO, PROCUREMENT OF SUBSTITUTE GOODS OR SERVICES; LOSS OF USE, DATA, OR PROFITS; OR BUSINESS INTERRUPTION) HOWEVER CAUSED AND ON ANY THEORY OF LIABILITY, WHETHER IN CONTRACT, STRICT LIABILITY, OR TORT (INCLUDING NEGLIGENCE OR OTHERWISE), EVEN IF ADVISED OF THE POSSIBILITY OF SUCH DAMAGE.

### **ETF - Sha1**

#### *License Text:*

Copyright © The Internet Society (2003). All Rights Reserved.

This document and translations of it may be copied and furnished to others, and derivative works that comment on or otherwise explain it or assist in its implementation may be prepared, copied, published and distributed, in whole or in part, without restriction of any kind, provided that the above copyright notice and this paragraph are included on all such copies and derivative works. However, this document itself may not be modified in any way, such as by removing the copyright notice or references to the Internet Society or other Internet organizations, except as needed for the purpose of developing Internet standards in which case the procedures for copyrights defined in the Internet Standards process must be followed, or as required to translate it into languages other than English.

The limited permissions granted above are perpetual and will not be revoked by the Internet Society or its successors or assigns. This document and the information contained herein is provided on an "AS IS" basis and THE INTERNET SOCIETY AND THE INTERNET ENGINEERING TASK FORCE DISCLAIMS ALL WARRANTIES, EXPRESS OR IMPLIED, INCLUDING BUT NOT LIMITED TO ANY WARRANTY THAT THE USE OF THE INFORMATION HEREIN WILL NOT INFRINGE ANY RIGHTS OR ANY IMPLIED WARRANTIES OF MERCHANTABILITY OR FITNESS FOR A PARTICULAR PURPOSE.

### **MEMTEST**

Description: General-purpose memory testing functions.

Notes: Some of the constants in this file are specific to Arcom's Target188EB hardware. This software can be easily ported to systems with different data bus widths by redefining `datum`.

Copyright © 1998 by Michael Barr. This software is placed into the public domain and may be used for any purpose. However, this notice must not be changed or removed and no warranty is either expressed or implied by its publication or distribution.

---

Copyright © 2016 ARRIS Enterprises, LLC. All rights reserved. No part of this publication may be reproduced in any form or by any means or used to make any derivative work (such as translation, transformation, or adaptation) without written permission from ARRIS Enterprises, Inc. ("ARRIS").

ARRIS reserves the right to revise this publication and to make changes in content from time to time without obligation on the part of ARRIS to provide notification of such revision or change. ARRIS provides this guide without warranty of any kind, either implied or expressed, including but not limited to the implied warranties of merchantability and fitness for a particular purpose. ARRIS may make improvements or changes in the product(s) described in this manual at any time.

ARRIS and the ARRIS Logo are registered trademarks trademarks of ARRIS Enterprises, Inc. Dolby Digital manufactured under license from Dolby Laboratories. Dolby and the double D symbol are registered trademarks of Dolby Laboratories. This product incorporates copyright protection technology that is protected by U.S. patents and other intellectual property rights. Use of this copyright protection technology must be authorized by Rovi Corporation, and is intended for home and other limited viewing uses only unless otherwise authorized by Rovi Corporation. Reverse engineering or disassembly is prohibited. Rovi is a protected trademark of Rovi Corporation. HDMI, the HDMI logo and High Definition Multimedia Interface are trademarks or registered trademarks of HDMI Licensing LLC. All other product or service names are the property of their respective owners.

The capabilities, system requirements and/or compatibility with third-party products described herein are subject to change without notice.





Visit our website at:  
[www.arris.com](http://www.arris.com)



598967-001-b  
02/2017

